

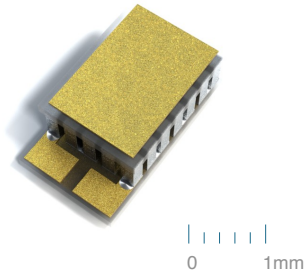

THERMOELECTRIC COOLER PERFORMANCE



ΔT_{max} K	Q_{max} W	I_{max} A	U_{max} V	ACR Ohm	Ambient Temperature	Conditions
72	0.51	0.4	2.1	4.2	+27°C / 300K	Vacuum
78	0.55	0.4	2.4	4.8	+50°C / 323K	Dry N2
84	0.60	0.4	2.6	5.3	+75°C / 348K	Dry N2
86	0.61	0.4	2.7	5.5	+85°C / 358K	Dry N2

Note: Thermoelectric Cooler performance values are specified for optimal conditions, assuming that TEC hot side (T_{hot}) is stabilized at ambient temperature (T_{amb})

TE COOLER TECHNICAL DRAWING

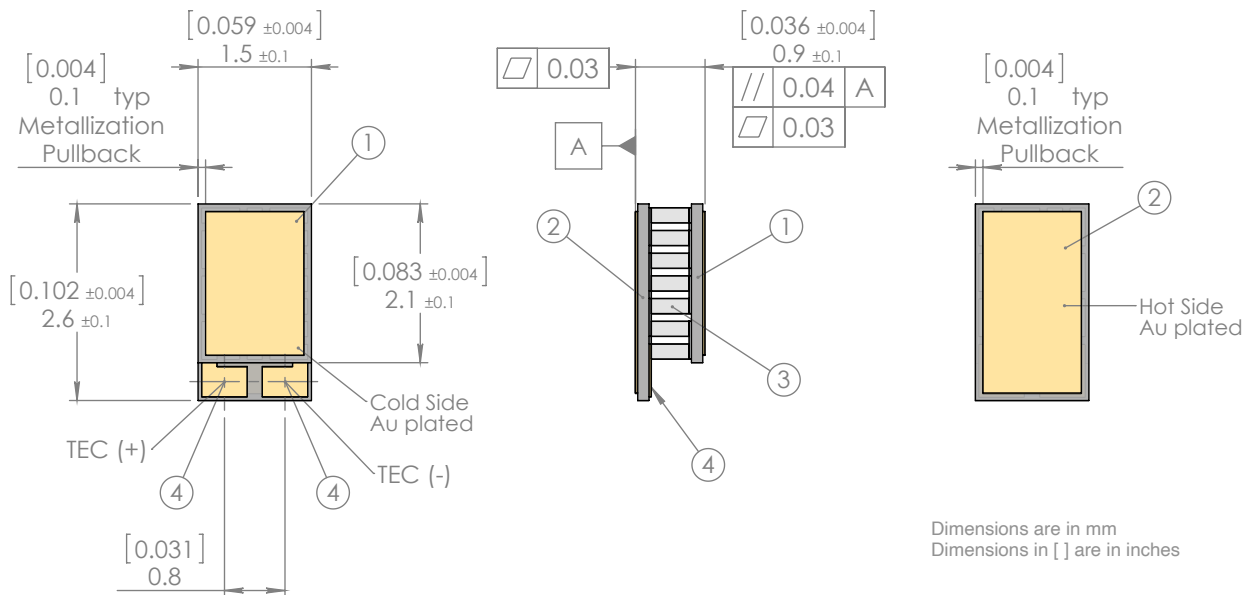

TEC DESCRIPTION

KEY FEATURES

- Cold Side (1) and Hot Side (2): ultra-thin AlN
- Internal Assembly: Solder Sn-Sb ($T_{melt}=230^{\circ}\text{C}$)
- Cold Side (1) Surface: Au plated (0.2 - 0.3um)
- Hot Side (2) Surface: Au plated (0.2 - 0.3um)
- Terminal Contacts (4): Wire Bonding (WB) Pads
- TEC Polarity: reversed by default
- Bi-Te Material (3): high-grade, hot-extruded type
- Protective Coating: N/A (available by request)
- Integrated Thermistor: N/A (available by request)

- Super-HD pellets placement technology
- RoHS EU Compliant
- REACH EU Compliant
- TELCORDIA GR-468 (MIL-883) qualified
- Front porch with WB Pads (default)
- WB Posts or wired configurations are available
- Up to 225°C short time processing (for mounting)
- Wide range of additional manufacturing options (see Pages 3,4)



TE COOLER PERFORMANCE PLOTS (COOLING MODE)

@27°C, Vacuum	ΔT_{max} K	Q_{max} W	I_{max} A	U_{max} V
1MD02-017-05ANt	72	0.51	0.4	2.1

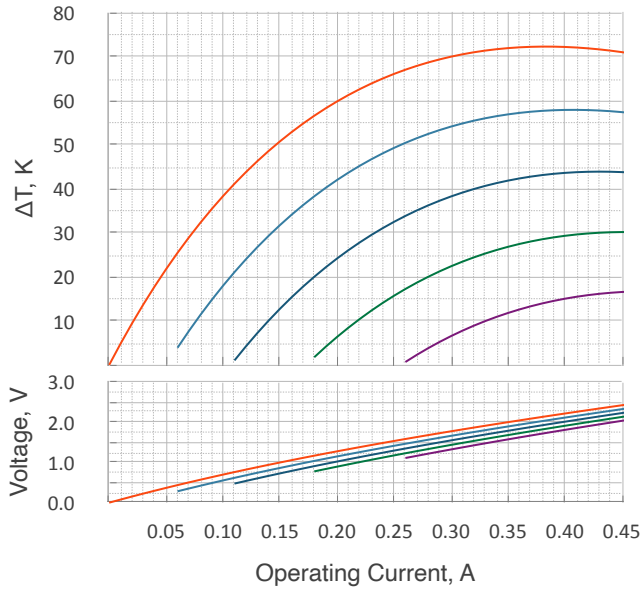

Heatload, W	0.0	0.10	0.20	0.31	0.41
% from Q_{max}	0%	20%	40%	60%	80%

@50°C, Dry N2	ΔT_{max} K	Q_{max} W	I_{max} A	U_{max} V
1MD02-017-05ANt	78	0.55	0.4	2.4

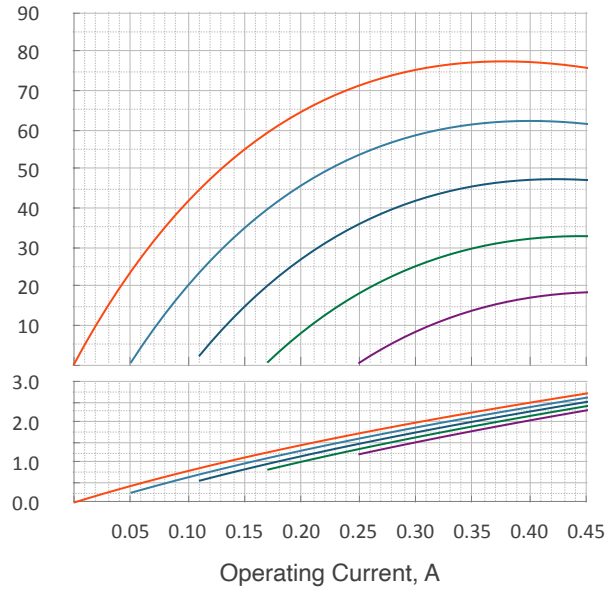

Heatload, W	0.0	0.11	0.22	0.33	0.44
% from Q_{max}	0%	20%	40%	60%	80%

@75°C, Dry N2	ΔT_{max} K	Q_{max} W	I_{max} A	U_{max} V
1MD02-017-05ANt	84	0.60	0.4	2.6

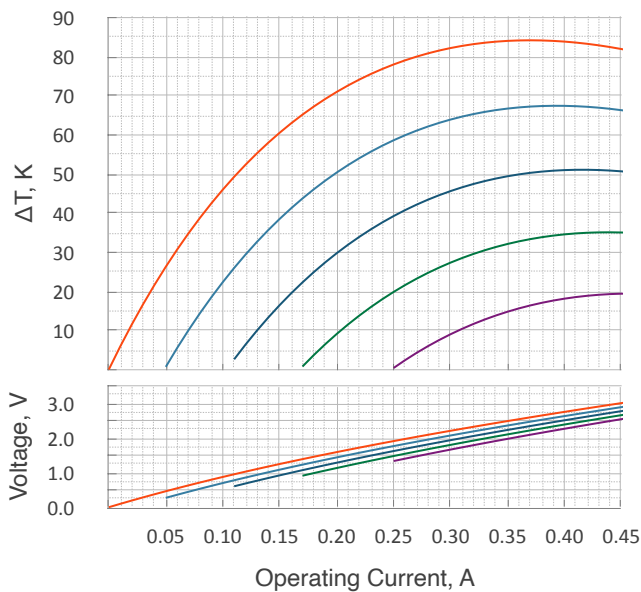

Heatload, W	0.0	0.12	0.24	0.36	0.48
% from Q_{max}	0%	20%	40%	60%	80%

@85°C, Dry N2	ΔT_{max} K	Q_{max} W	I_{max} A	U_{max} V
1MD02-017-05ANt	86	0.61	0.4	2.7

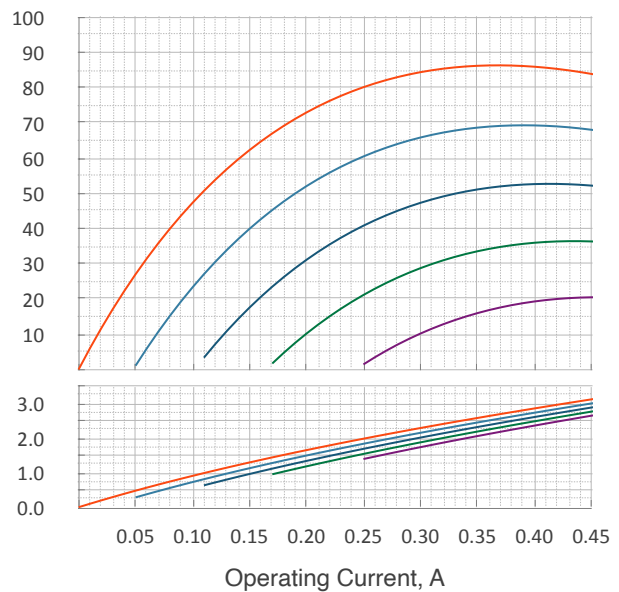

Heatload, W	0.0	0.12	0.24	0.37	0.49
% from Q_{max}	0%	20%	40%	60%	80%

Note: Thermoelectric cooler performance values and plots are specified at optimal conditions, assuming TEC hot side is stabilized at ambient temperature ($T_{hot}=T_{amb}$). The performance data is specified for four most common ambient condition modes. Please, contact TEC Microsystems GmbH directly for estimations under different conditions, if required.



THERMOELECTRIC COOLER TERMINAL CONNECTION OPTIONS

			
<input checked="" type="checkbox"/> Wire Bonding (WB) Pads	<input type="checkbox"/> Wire Bonding Posts	<input type="checkbox"/> Wire Bonding Posts (variable)	<input type="checkbox"/> Side Wire Bonding (WB) Pads
			
<input type="checkbox"/> Terminal Wires (blank)	<input type="checkbox"/> Terminal Wires (insulated)	<input type="checkbox"/> Terminal Wires (insulated, color-coded)	<input type="checkbox"/> SMD / Flip-chip (contacts on hot side)

● - By default thermoelectric cooler is provided with Wire Bonding (WB) Pads. Various TEC terminal connection options are available by request. In case of terminal wires wire type, material, length and diameter can be specified by customer.

THERMOELECTRIC COOLER SURFACE OPTIONS

Standard ceramics surface options, available without price change. The metallization and pre-tinning are possible to apply for one side or both TEC sides.

		
<input checked="" type="checkbox"/> Au plated (both sides)	<input type="checkbox"/> Pre-tinned with solder	<input type="checkbox"/> Blank ceramics (no metallization)

Advanced ceramics surface options, available by request

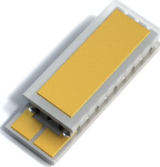
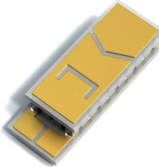
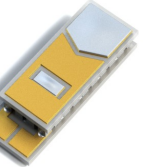
		
<input type="checkbox"/> Custom metallization gap	<input type="checkbox"/> Customized Au pattern	<input type="checkbox"/> Selective zone pre-tinning over Au pattern

● - By default thermoelectric cooler is provided with Au plated ceramics surfaces (both sides). This is the universal solution, suitable for soldering and gluing. Surface solution can be specified for each TEC side (top and bottom ceramics surfaces) individually.



1MD02 SERIES THERMOELECTRIC COOLERS OVERVIEW



- SuperHD BiTe pellets placement technology, more than 1100 BiTe pellets per cm² density.
- Low-current ultra-miniature Thermoelectric Coolers with a focus on telecom applications.
- Thermoelectric Coolers from 1MD02 Series have a front porch on bottom ceramics for optimal wires or WB pads/posts integrating. The default TEC manufacturing configuration has Wire Bonding (WB) Pads.
- Thermoelectric Coolers manufacturing configurations with Wire Bonding (WB) Posts, various terminal wires or special SMD solutions are available by request.
- Thermoelectric Cooler internal Assembly Solder by default: Sn-Sb, T_{melt}=230°C, other solutions are available by request.



RoHS Compliant

APPLICATION TIPS

- Maximum **short time process** temperature is 220°C (TEC assembly solder has T_{melt}=230°C).
- Maximum **long time operating** temperature is 150°C.
- Use thermoelectric cooler only with an appropriate heat sink attached to the hot side.
- Connect thermoelectric cooler to DC power supply in according to TEC polarity.
- Do not exceed DC current and voltage higher than I_{max} and U_{max} values.
- Use temperature ramping and avoid thermal shocks during soldering and/or baking processes.
- Check [FAQ](#) on TEC Microsystems web for more details about TECs operating and handling.

220

150



TEC Lifetime depends on Ambient Temperature (T_{amb}) and can be estimated by Arrhenius equation



Term "Lifetime" for TEC is taken from Telcordia GR-468 Standard. The criteria of failure is TEC AC Resistance (ACR) change for more than 5%. It doesn't mean TEC stops operating, but certain performance degradation appears.



IMPORTANT NOTES

1. Thermoelectric Cooler (TEC) performance in this datasheet is specified in typical ambient condition modes (Vacuum, +27°C; Dry N2, +50°C; Dry N2, +75°C and Dry N2, +85°C. TEC performance may differ under other conditions. Please, contact TEC Microsystems for detailed analysis and additional TEC performance info.
2. TEC ACR and U_{max} values are sensitive to ambient temperature. These values can be different from those specified in the datasheet at other ambient conditions. ACR and U_{max} rise with ambient temperature increasing.
3. TEC dT_{max} is specified at zero heatload, while Q_{max} is specified at zero dT (check Fig.1 for example). TEC dT_{max} and Q_{max} values rise with ambient temperature (check Fig. 2 for example).
4. Thermoelectric coolers have the best performance in the temperature range from near room up to +80..90°C. TEC cooling performance is getting lower at ambient temperatures below 0°C. TECs are not suitable to operate at cryogenic temperatures.

Fig. 1 - Understanding dT_{max} and Q_{max}



Fig. 2 - Same TEC dT_{max} and Q_{max} parameters at different ambient temperatures



5. Driving TEC at I_{max} or U_{max} level doesn't mean the max cooling performance mode. The real optimal mode may depend on operating conditions, required dT level and application heatload. In fact a better performance can be reached at operating current and voltage lower than I_{max} and U_{max} values specified in datasheet.
6. It is strongly recommended to avoid a direct mounting of thermoelectric cooler to pure Copper, Aluminium or Nickel materials as well as a mounting of objects from these materials on TEC cold side. Any material with high CTE (Coefficient of Thermal Expansion) may affect on TEC lifetime and/or even damage TEC in case of improper mounting, thermal shock or temperature cycling. In case of above mentioned materials necessity, it is recommended to use some elastic "soft" solders or glues with large modulus of elasticity (Indium-based solders or silicon-based thermoconductive glues).
7. TEC Microsystems GmbH confirms that all thermoelectric coolers are qualified and meet the requirements of Telcordia GR-468 Standard (based on MIL-883). The up-to-date Reliability Report is available by request. TEC Microsystems GmbH warranties thermoelectric coolers lifetime no less than 250K-300K operating hours under normal application conditions.
8. Additional information about thermoelectric coolers operating and handling, all the most important questions and answers, are available on TEC Microsystems web in FAQ section ([link](#)).



LEGAL NOTICE

All logos, images, trademarks and product names (collectively Materials) are proprietary to TEC Microsystems GmbH and/ or any of its affiliates, branches or subsidiaries, or other respective owners that have granted TEC Microsystems GmbH the permission and/or license to use such Materials.

All images are provided by TEC Microsystems GmbH and are subjects of copyright protection.

TEC Microsystems GmbH does not grant a copyright license (express or implied) to the Recipient, except that Recipient may reproduce the logos, images and text materials in this press-release without any alteration for non-promotional or editorial purposes only with a written note about materials owner.

COPYRIGHT PROTECTION

Graphics materials and texts from this datasheet may not be used commercially without a prior response in writing on company letterhead and signed by TEC Microsystems GmbH authority.

Thank you for respecting the intellectual property rights protected by the International Copyright laws.

All Images contain TEC Microsystems GmbH hidden watermarks for the immediate proof of their origin.



TEC Microsystems GmbH
images



Hidden Watermark
verification