

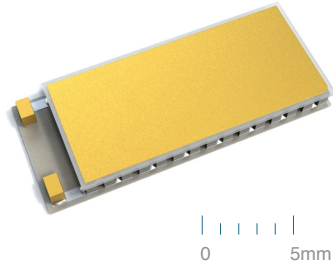

## THERMOELECTRIC COOLER PERFORMANCE



$\Delta T_{max}$ K	$Q_{max}$ W	$I_{max}$ A	$U_{max}$ V	ACR Ohm	Ambient Temperature	Conditions
71	9.1	2.3	6.5	2.2	+27°C / 300K	Vacuum
75	10.0	2.3	7.1	2.4	+50°C / 323K	Dry N2
81	10.7	2.2	7.8	2.7	+75°C / 348K	Dry N2
83	11.0	2.2	8.1	2.8	+85°C / 358K	Dry N2

**Note:** Thermoelectric Cooler performance values are specified for optimal conditions, assuming that TEC hot side ( $T_{hot}$ ) is stabilized at ambient temperature ( $T_{amb}$ )

## TECHNICAL DRAWING

## 1ML06-052-07AN25

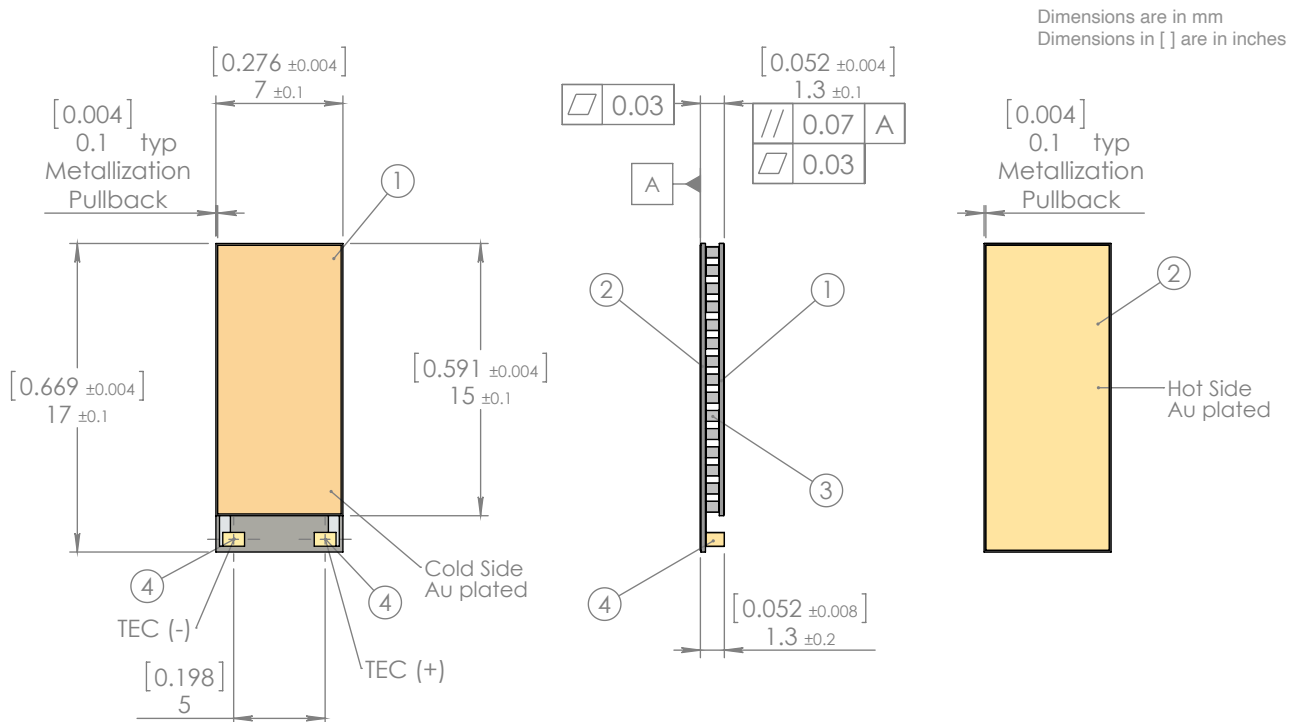

## TEC DESCRIPTION

- Ceramics: AlN (Aluminium Nitride)
- Internal Assembly: Solder Sn-Sb ( $T_{melt}=230^{\circ}\text{C}$ )
- Cold Side Surface: Au plated (0.2 - 0.3 $\mu\text{m}$ )
- Hot Side Surface: Au plated (0.2 - 0.3 $\mu\text{m}$ )
- Terminal Contacts: WB Posts by default
- TEC Polarity: standard
- Bi-Te Material: high-grade, hot-extruded type
- Protective Coating: N/A (available by request)
- Integrated Thermistor: N/A (available by request)

## KEY FEATURES

- Regular BiTe pellets placement technology
- RoHS EU Compliant
- REACH EU Compliant
- TELCORDIA GR-468 (MIL-883) qualified
- Classical shape (equal size of top and bottom)
- WB configuration is available by request
- Up to 225°C short time processing (for mounting)
- Wide range of additional manufacturing options (see Pages 3,4)



## PERFORMANCE PLOTS

@27°C, Vacuum	$\Delta T_{max}$ K	$Q_{max}$ W	$I_{max}$ A	$U_{max}$ V
1ML06-052-07AN25	71	9.1	2.3	6.5

@50°C, Dry N2	$\Delta T_{max}$ K	$Q_{max}$ W	$I_{max}$ A	$U_{max}$ V
1ML06-052-07AN25	75	10.0	2.3	7.1

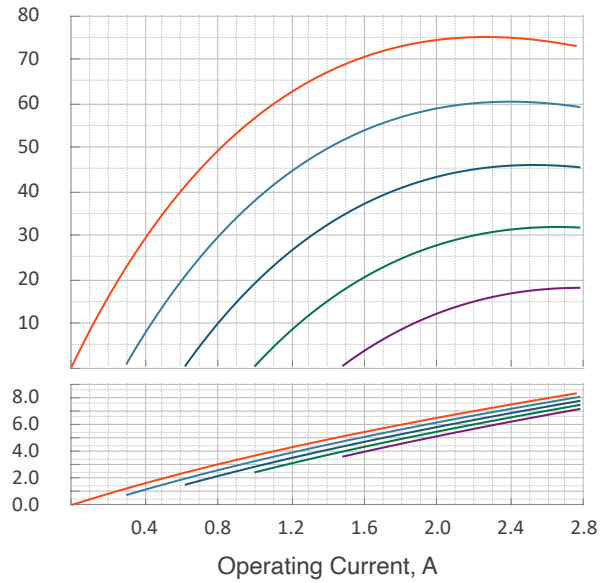
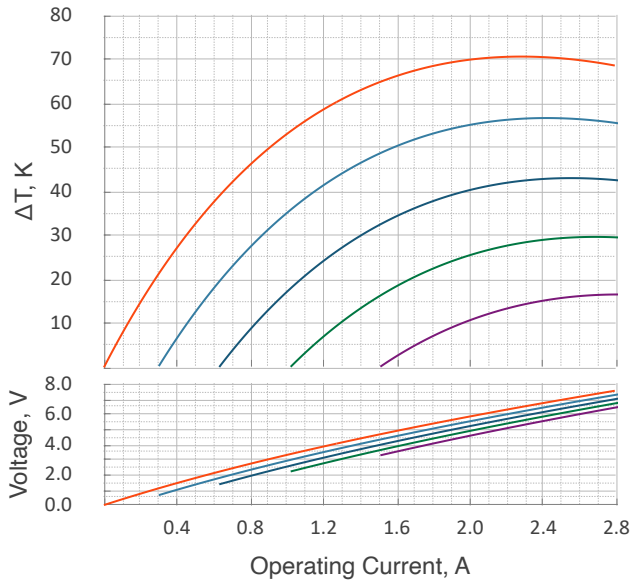

Heatload, W	0.0	1.8	3.6	5.5	7.3
% from $Q_{max}$	0%	20%	40%	60%	80%

Heatload, W	0.0	2.0	4.0	6.0	8.0
% from $Q_{max}$	0%	20%	40%	60%	80%

@75°C, Dry N2	$\Delta T_{max}$ K	$Q_{max}$ W	$I_{max}$ A	$U_{max}$ V
1ML06-052-07AN25	81	10.7	2.2	7.8

@85°C, Dry N2	$\Delta T_{max}$ K	$Q_{max}$ W	$I_{max}$ A	$U_{max}$ V
1ML06-052-07AN25	83	11.0	2.2	8.1

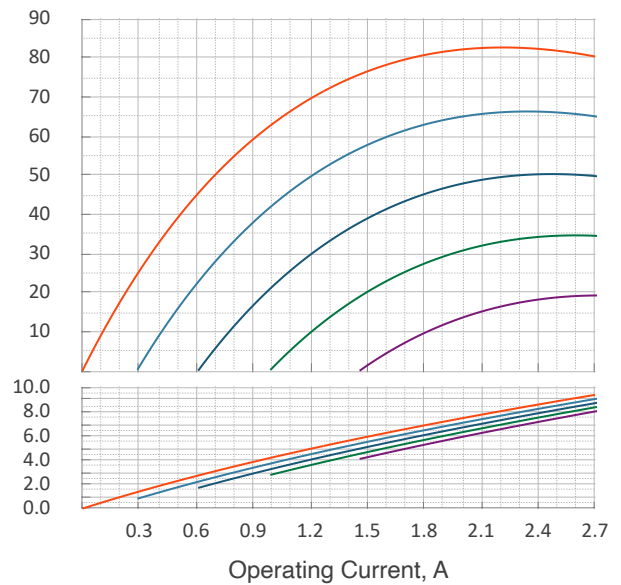
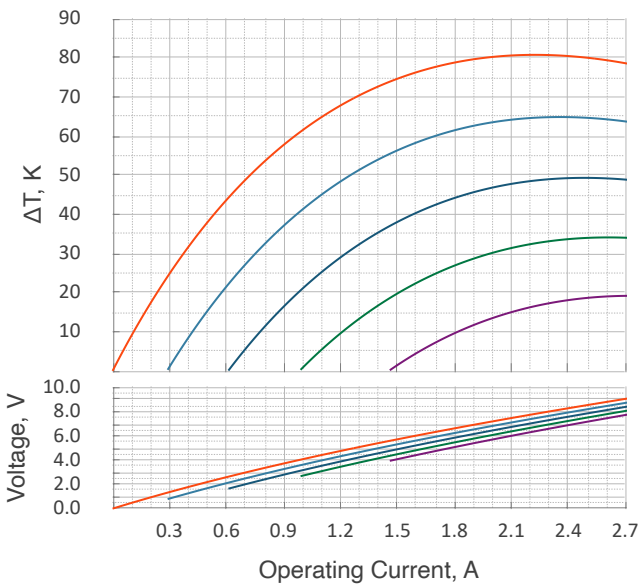

Heatload, W	0.0	2.1	4.3	6.4	8.6
% from $Q_{max}$	0%	20%	40%	60%	80%

Heatload, W	0.0	2.2	4.4	6.6	8.8
% from $Q_{max}$	0%	20%	40%	60%	80%

**Note:** Thermoelectric cooler performance values and plots are specified at optimal conditions, assuming TEC hot side is stabilized at ambient temperature ( $T_{hot}=T_{amb}$ ). The performance data is specified for four most common ambient condition modes. Please, contact TEC Microsystems GmbH directly for estimations under different conditions, if required.



### THERMOELECTRIC COOLER TERMINAL CONNECTION OPTIONS

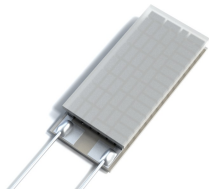

Blank Wires

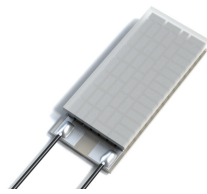

Insulated Wires

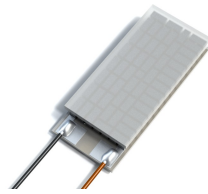

Insulated Color-coded Wires

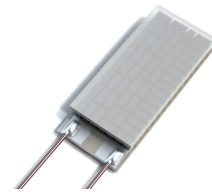

Varnished Wires



WB Pads



WB Posts

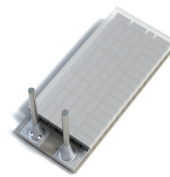

Terminal Rods

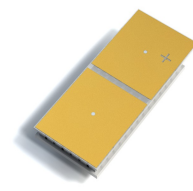

SMD / Flip-chip (contacts on hot side)

● - By default this particular thermoelectric cooler is provided with wire bonding (WB) posts. Various TEC terminal connection options are available by request. In the case of a thermoelectric cooler with wires, customer can select the wire type, diameter, and length.

### THERMOELECTRIC COOLER SURFACE OPTIONS

Standard ceramics surface options are available without price change.

Pre-tinning can be applied to one side of the TEC or both.

Different solder types are available for pre-tinning.

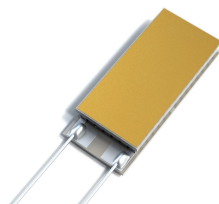

Au plated



Pre-tinned with solder

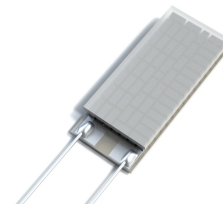

Blank ceramics (w/o metallization)

Advanced ceramics surface options, available by request.

Surface customization can be applied to one side of the TEC or both.

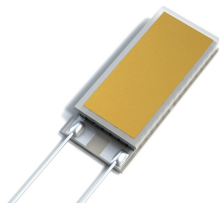

Custom gap

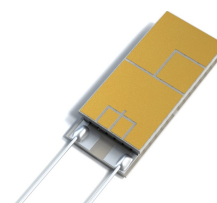

Customized Au pattern

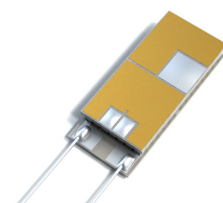

Selective pre-tinning over pattern

● - By default thermoelectric cooler is provided with Au plated ceramics surfaces (both sides). Au plated surface is the universal solution, suitable for soldering and gluing. Surface type and configuration can be specified individually for each TEC side (top and bottom ceramics surfaces).



### 1ML06 SINGLE-STAGE TE COOLER OVERVIEW (STANDARD TEC SHAPE)



- TE Coolers with standard shapes have the same cold and hot sides by dimensions.
- TEC configurations with WB pads or WB posts are possible but require TEC hot side modification.
- TEC internal Assembly Solder by default: Sn-Sb,  $T_{melt}=230^{\circ}C$



RoHS Compliant

### APPLICATION TIPS

- Maximum **short time process** temperature is  $220^{\circ}C$  (TEC assembly solder has  $T_{melt}=230^{\circ}C$ ).
- Maximum **long time operating** temperature is  $150^{\circ}C$ .
- Use thermoelectric cooler only with an appropriate heat sink attached to the hot side.
- Connect thermoelectric cooler to DC power supply in according to TEC polarity.
- Do not exceed DC current and voltage higher than  $I_{max}$  and  $U_{max}$  values.
- Use temperature ramping and avoid thermal shocks during soldering and/or baking processes.
- Check [FAQ](#) on TEC Microsystems web for more details about TECs operating and handling.

220

150



TEC Lifetime depends on Ambient Temperature ( $T_{amb}$ ) and can be estimated by Arrhenius equation



Term "Lifetime" for TEC is taken from Telcordia GR-468 Standard. The criteria of failure is TEC AC Resistance (ACR) change for more than 5%. It doesn't mean TEC stops operating, but certain performance degradation appears.



## IMPORTANT NOTES

1. Thermoelectric Cooler (TEC) performance in this datasheet is specified in typical ambient condition modes (Vacuum, +27°C; Dry N2, +50°C; Dry N2, +75°C and Dry N2, +85°C. TEC performance may differ under other conditions. Please, contact TEC Microsystems for detailed analysis and additional TEC performance info.
2. TEC ACR and  $U_{max}$  values are sensitive to ambient temperature. These values can be different from those specified in the datasheet at other ambient conditions. ACR and  $U_{max}$  rise with ambient temperature increasing.
3. TEC  $dT_{max}$  is specified at zero heatload, while  $Q_{max}$  is specified at zero  $dT$  (check Fig.1 for example). TEC  $dT_{max}$  and  $Q_{max}$  values rise with ambient temperature (check Fig. 2 for example).
4. Thermoelectric coolers have the best performance in the temperature range from near room up to +80..90°C. TEC cooling performance is getting lower at ambient temperatures below 0°C. TECs are not suitable to operate at cryogenic temperatures.

Fig. 1 - Understanding  $dT_{max}$  and  $Q_{max}$



Fig. 2 - Same TEC  $dT_{max}$  and  $Q_{max}$  parameters at different ambient temperatures



5. Driving TEC at  $I_{max}$  or  $U_{max}$  level doesn't mean the max cooling performance mode. The real optimal mode may depend on operating conditions, required  $dT$  level and application heatload. In fact a better performance can be reached at operating current and voltage lower than  $I_{max}$  and  $U_{max}$  values specified in datasheet.
6. It is strongly recommended to avoid a direct mounting of the thermoelectric cooler to pure Copper, Aluminium or Nickel materials and a mounting of objects from these materials on the TEC cold side. Any material with high CTE (Coefficient of Thermal Expansion) may affect TEC lifetime and even damage TEC in case of improper mounting, thermal shock or temperature cycling. In case of the necessity of the material as mentioned above, it is recommended to use some elastic "soft" solders or glues with a large modulus of elasticity (Indium-based solders or silicon-based thermoconductive glues).
7. TEC Microsystems GmbH confirms that all thermoelectric coolers are qualified and meet the requirements of Telcordia GR-468 Standard (based on MIL-883). The up-to-date Reliability Report is available by request. TEC Microsystems GmbH warranties thermoelectric coolers lifetime no less than 250K-300K operating hours under normal application conditions.
8. Additional information about thermoelectric coolers operating and handling, all the most important questions and answers, are available on TEC Microsystems web in FAQ section ([link](#)).



## LEGAL NOTICE

---

All logos, images, trademarks and product names (collectively Materials) are proprietary to TEC Microsystems GmbH and/ or any of its affiliates, branches or subsidiaries, or other respective owners that have granted TEC Microsystems GmbH the permission and/or license to use such Materials.

All images are provided by TEC Microsystems GmbH and are subjects of copyright protection.

TEC Microsystems GmbH does not grant a copyright license (express or implied) to the Recipient, except that Recipient may reproduce the logos, images and text materials in this press-release without any alteration for non-promotional or editorial purposes only with a written note about materials owner.

## COPYRIGHT PROTECTION

---

Graphics materials and texts from this datasheet may not be used commercially without a prior response in writing on company letterhead and signed by TEC Microsystems GmbH authority.

Thank you for respecting the intellectual property rights protected by the International Copyright laws.

All Images contain TEC Microsystems GmbH hidden watermarks for the immediate proof of their origin.



TEC Microsystems GmbH  
images



Hidden Watermark  
verification